



磁立方

SPECIFICATION FOR APPROVAL

CUSTOMER : _____

CUSTOMER P/N : _____

DESCRIPTION : SMD Inductor

Supplier P/N : SBCM0905-652P

REVISION NO. : V1.0

DATE : 2021-Jan-14

NOTES : STANDARD

Supplier DOCUMENTED	
APPROVED	David
CHECKED	Zhao yun
PREPARED	You yuan

CUSTOMER APPROVAL	

© Company seals

Version:1.0	CUSTOMER P/N	PRODUCT	SMD Inductor
	ITEM P/N	DATE	2021-Jan-14



深圳市磁立方科技有限公司
ShenZhen Magnetic Cube Technology Co., LTD.

TEL:0755-23018051 E-FAX:0755-22140304 E-MAIL:Sales@mct8.com HTTP:www.mct8.com
ADD:F2, Building C, Furong Road No.8 , Tantou, Songgang, Baoan District, Shenzhen



MAIN SPECIFICATION

EXPLANATION OF PART NUMBERS

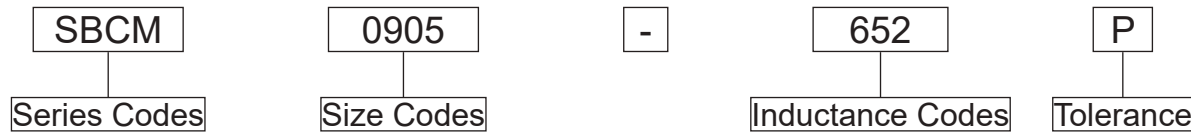

Schematic:

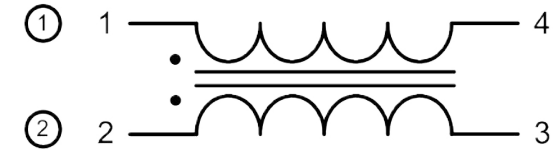

PRODUCT DIMENSIONS (mm)

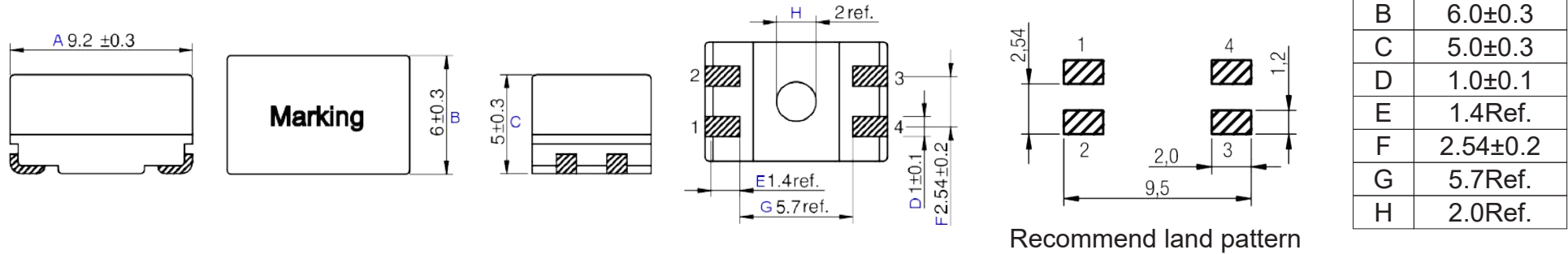

ELECTRICAL CHARACTERISTICS

ITEM P/N	@25±5°C Ambient Temperature				DCR(Ω) @25°C Max	Winding Style
	Inductance 10kHz/50mV	Leakage inductance	Max Heat Rating DC Current(A) (I _{dc})	Z(Ω) @25°C Typ.		
	L(μH)	L _s (nH)(Typ.) 1000KHz,0.1V				
SBCM0905-652P	6500±30%	280	0.4	18400	0.95	bifilar

- ◎ All test Data is referenced to 25°C ambient.
- ◎ Max Heat Rating DC Current would cause an approximately ΔT of 40°C.
- ◎ Max Saturation DC Current would cause L_o to drop approximately 30%.
- ◎ The Part temperature (ambient + ΔT) should not exceed 125°C under worst case operating conditions.
- ◎ Circuit design, component placement, PWB trace size and thickness, airflow and other cooling provisions all effect the part temperature. Part temperature should be verified in the end application.

Version:1.0	CUSTOMER P/N		PRODUCT	SMD Inductor
	ITEM P/N	SBCM0905-652P	DATE	2021-Jan-14



深圳市磁立方科技有限公司
ShenZhen Magnetic Cube Technology Co., LTD.

TEL:0755-23018051 E-FAX:0755-22140304 E-MAIL:Sales@mct8.com HTTP:www.mct8.com
ADD:F2, Building C, Furong Road No.8, Tantou, Songgang, Baoan District, Shenzhen



CHARACTERISTICS

Typical Impedance Characteristics:

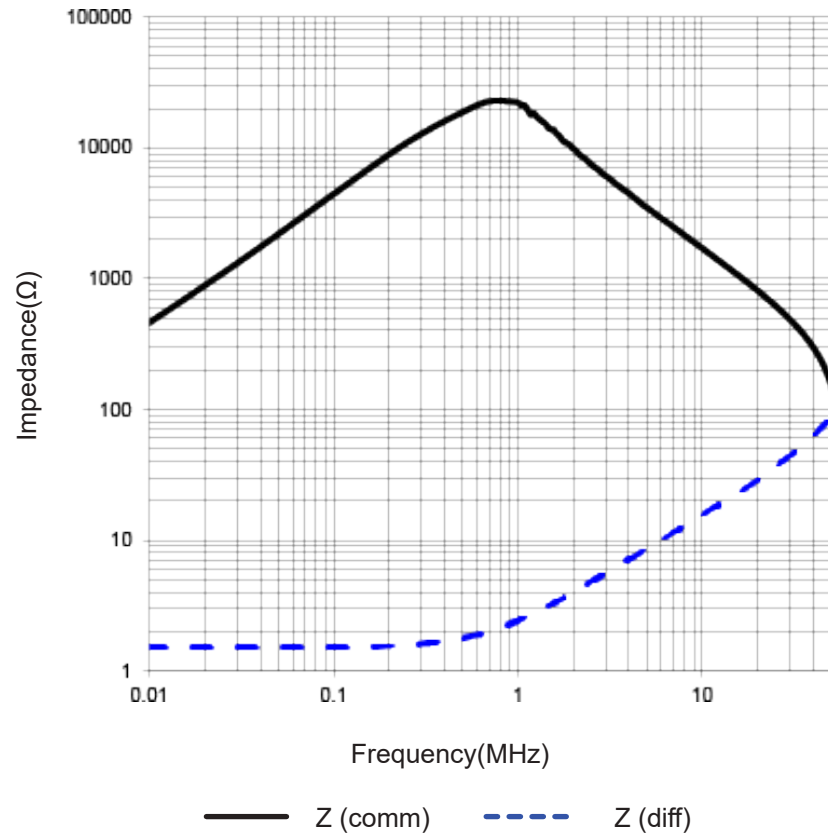

Test Setup:

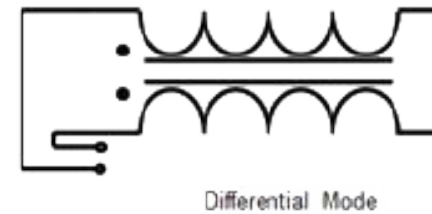
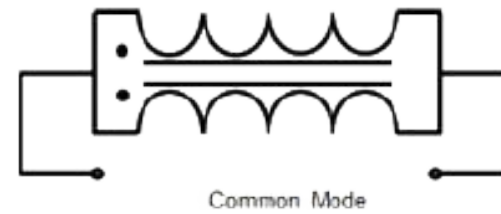

Version:1.0	CUSTOMER P/N		PRODUCT	SMD Inductor
	ITEM P/N	SBCM0905-652P	DATE	2021-Jan-14



深圳市磁立方科技有限公司
ShenZhen Magnetic Cube Technology Co., LTD.

TEL:0755-23018051 E-FAX:0755-22140304 E-MAIL:Sales@mct8.com HTTP:www.mct8.com
ADD:F2, Building C, Furong Road No.8 , Tantou, Songgang, Baoan District, Shenzhen



CHARACTERISTICS

RECOMMENDED SOLDERING TEMP. GRAPH



A	B	C	D	E
260°C	230°C	8-10Sec	150°C	60~240Sec

MECHANICAL RELIABILITY

TEST	Specification & Requirement	Method Used
Solderability	The surface of terminal/pin tested shall be covered with new solder by 95%	Solder heat proof.
		Preheating: 180 ±10°C 90 seconds
		Soldering: 255 ±5°C for 3 ±1 sec
Shock	Inductance change within ± 5% Without mechanical damage	Drop down with 981m/s ² (100G) shock
		Attitude upon a rubber block method shock testing machinem, 3 tests.
Vibration	Inductance change within ± 5% Without mechanical damage	Vibration frequency: 10Hz to 55Hz to 10Hz, 60 seconds cycle.
		Vibration time: 2 hours

ENDURANCE RELIABILITY

TEST	Specification & Requirement	Method Used
Thermal Shock	Inductance change within ± 5% Without mechanical damage	-25°C ,(30 mins) -> room temp. (5 mins) ->125°C , (30 mins) -> room temp. (5 mins) 100 cycles
Heat Resistance	Inductance change within ± 5% Without mechanical damage	Apply IDC current @ 85°C ambient Duration: 1000 hrs
Humidity Resistance	Inductance change within ± 5% Without mechanical damage	Apply IDC current @ 60°C ambient Humidity: 90~95% Duration: 1000 hrs
Low Temp. Storing	Inductance change within ± 5% Without mechanical damage	Storing Temp -25 ±2 °C for total 1,000 +4/-0 hours
High Temp. Storing	Inductance change within ± 5% Without mechanical damage	Storing Temp 125±2 °C for total 1,000 +4/-0 hours

Version:1.0	CUSTOMER P/N	SBCM0905-652P	PRODUCT	SMD Inductor
	ITEM P/N		DATE	2021-Jan-14



深圳市磁立方科技有限公司
ShenZhen Magnetic Cube Technology Co., LTD.

TEL:0755-23018051 E-FAX:0755-22140304 E-MAIL:Sales@mct8.com HTTP:www.mct8.com
ADD:F2, Building C, Furong Road No.8 , Tantou, Songgang, Baoan District, Shenzhen



PACKING INFORMATION

CARRIER TAPEING REEL & CARRIER MATERIALS (PAPER PLASTICS) UNIT : (mm)

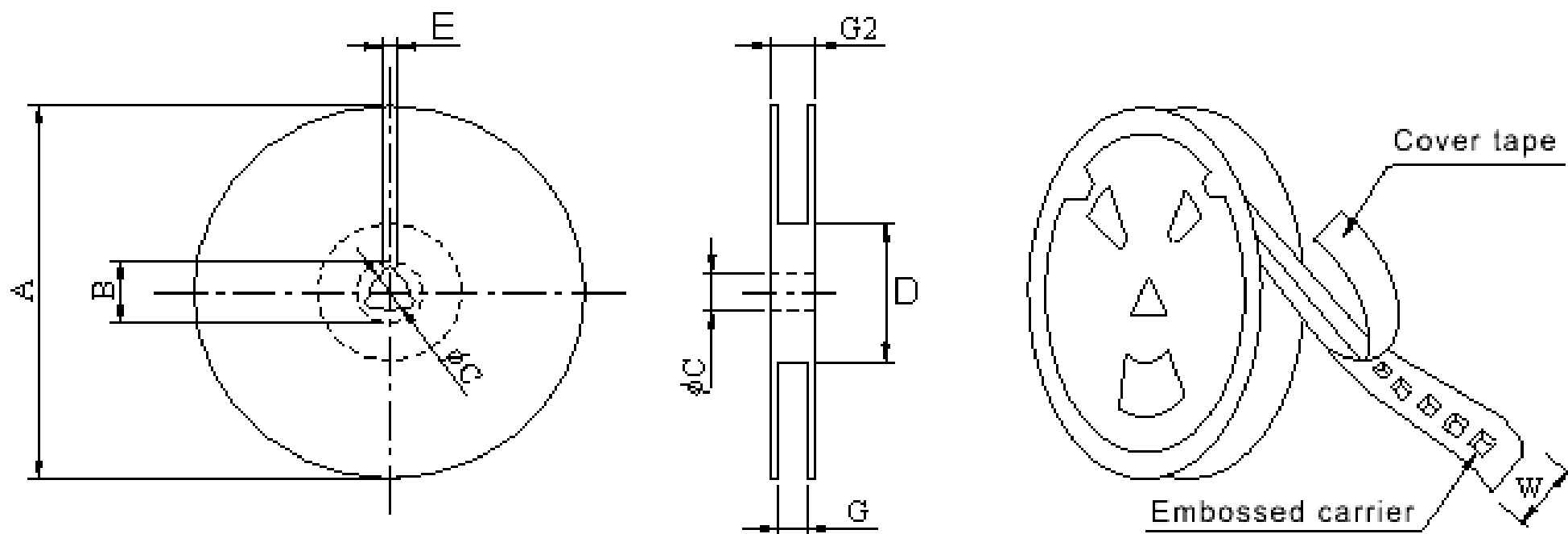

TYPE	A	B	C	D	E	G	G2
330*16mm	330±1	20±0.8	13±0.5	100±1	2.0±0.5	16.5±0.5	20.5±0.5

Version:1.0	CUSTOMER P/N		PRODUCT	SMD Inductor
	ITEM P/N	SBCM0905-652P	DATE	2021-Jan-14



深圳市磁立方科技有限公司
ShenZhen Magnetic Cube Technology Co., LTD.

TEL:0755-23018051 E-FAX:0755-22140304 E-MAIL:Sales@mct8.com HTTP:www.mct8.com
ADD:F2, Building C, Furong Road No.8 , Tantou, Songgang, Baoan District, Shenzhen



PACKING INFORMATION

CARRIER TAPEING REEL & CARRIER MATERIALS (PAPER PLASTICS) UNIT : (mm)



QTY (Pcs/Reel)	Ao	Bo	Ko	W	P
1000	6.5	9.7	5.7	16	12

Typical Pulling Force: 10~130grams:



Version:1.0	CUSTOMER P/N	SBCM0905-652P	PRODUCT	SMD Inductor
	ITEM P/N		DATE	2021-Jan-14



深圳市磁立方科技有限公司
ShenZhen Magnetic Cube Technology Co., LTD.

TEL:0755-23018051 E-FAX:0755-22140304 E-MAIL:Sales@mct8.com HTTP:www.mct8.com
ADD:F2, Building C, Furong Road No.8, Tantou, Songgang, Baoan District, Shenzhen

