



磁立方

SPECIFICATION FOR APPROVAL

CUSTOMER : _____

CUSTOMER P/N : _____

DESCRIPTION : SMD Inductor

Supplier P/N : SICM0510-2R2M

REVISION NO. : V1.0

DATE : 2022-Sep-06

NOTES : STANDARD

Supplier DOCUMENTED	
APPROVED	David
CHECKED	Zhao yun
PREPARED	You yuan

CUSTOMER APPROVAL	

© Company seals

Version:1.0	CUSTOMER P/N	PRODUCT	SMD Inductor
	ITEM P/N	DATE	2022-Sep-06



深圳市磁立方科技有限公司
ShenZhen Magnetic Cube Technology Co., LTD.

TEL:0755-23018051 E-FAX:0755-22140304 E-MAIL:Sales@mct8.com HTTP:www.mct8.com
ADD:F2, Building C, Furong Road No.8 , Tantou, Songgang, Baoan District, Shenzhen



MAIN SPECIFICATION

EXPLANATION OF PART NUMBERS



Schematic:

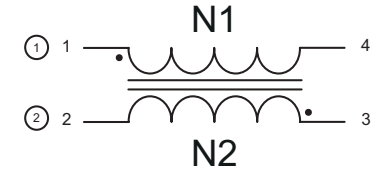

PRODUCT DIMENSIONS (mm)

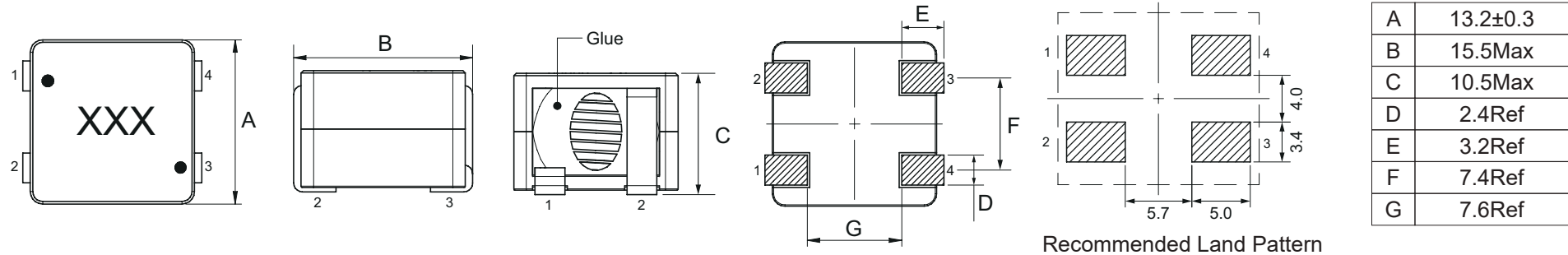

ELECTRICAL CHARACTERISTICS

ITEM P/N	@ 25 ± 5°C Ambient Temperature			DCR @ 25°C R(1-4),R(2-3) (mΩ)Typ.	DCR @ 25°C R(1-4),R(2-3) (mΩ)Max.
	INDUCTANCE 100KHz, 0.1V	Typical Heat Rating DC Current (A) (I _{dc})	Typical Saturation DC Current (A) (I _{sat})		
	L(1-4),L(3-2) (μH)				
SICM0510-2R2M	2.2±20%	18.0	35.0	4.2	4.62

- ⊙ All test Data is referenced to 25°C ambient.
- ⊙ Typical Heat Rating DC Current would cause an Δ T approximately 40°C .
- ⊙ Typical Saturation DC Current would cause L_o to drop approximately 30%.
- ⊙ The Part temperature (ambient + Δ T) should not exceed 125°C under worst case operating conditions.
- ⊙ Circuit design, component placement, PWB trace size and thickness, airflow and other cooling provisions all effect the part temperature. Part temperature should be verified in the end application.

Version:1.0	CUSTOMER P/N		PRODUCT	SMD Inductor
	ITEM P/N	SICM0510-2R2M	DATE	2022-Sep-06

 深圳市磁立方科技有限公司 TEL:0755-23018051 E-FAX:0755-22140304 E-MAIL:Sales@mct8.com HTTP:www.mct8.com
ShenZhen Magnetic Cube Technology Co., LTD. ADD:F2, Building C, Furong Road No.8 , Tantou, Songgang, Baoan District, Shenzhen



CHARACTERISTICS

Typical Inductance vs. Current Characteristics:

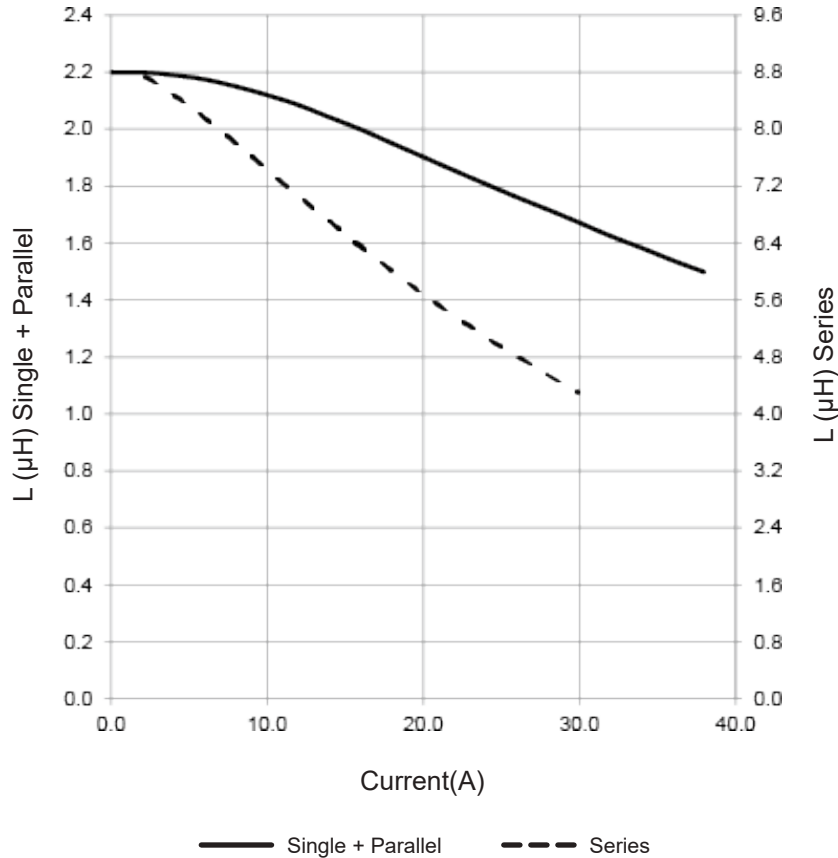

Typical Temperature Rise vs. Current Characteristics:

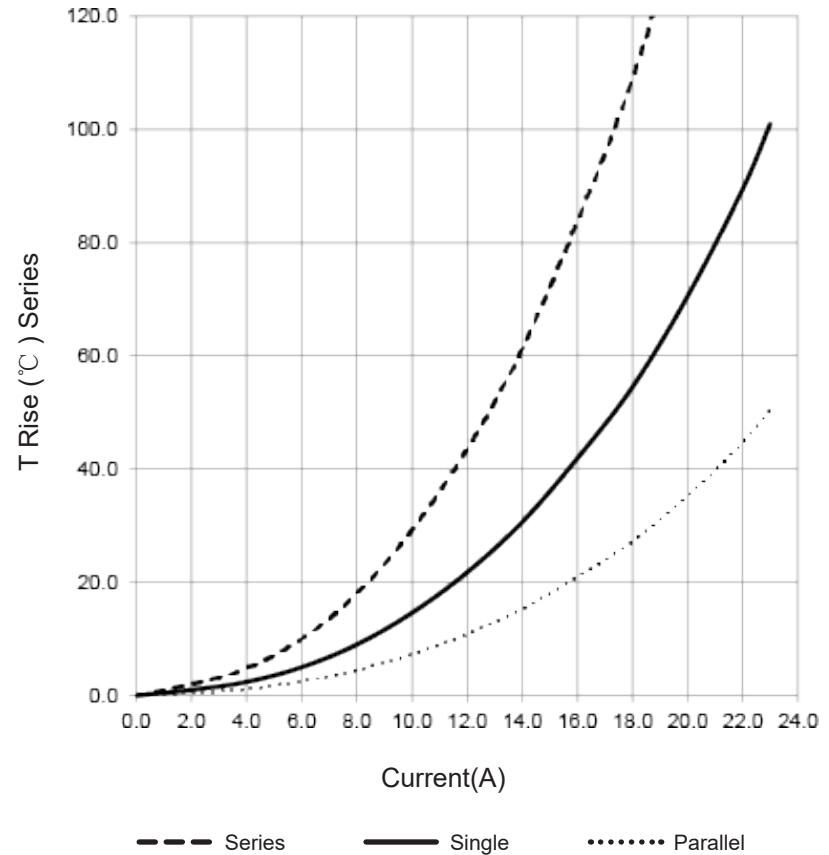

Version:1.0	CUSTOMER P/N		PRODUCT	SMD Inductor
	ITEM P/N	SICM0510-2R2M	DATE	2022-Sep-06



深圳市磁立方科技有限公司
ShenZhen Magnetic Cube Technology Co., LTD.

TEL:0755-23018051 E-FAX:0755-22140304 E-MAIL:Sales@mct8.com HTTP:www.mct8.com
ADD:F2, Building C, Furong Road No.8 , Tantou, Songgang, Baoan District, Shenzhen



CHARACTERISTICS

RECOMMENDED SOLDERING TEMP. GRAPH



A	B	C	D	E
260°C	230°C	8-10Sec	150°C	60~240Sec

MECHANICAL RELIABILITY

TEST	Specification & Requirement	Method Used
Solderability	The surface of terminal/pin tested shall be covered with new solder by 95%	Solder heat proof.
		Preheating: 180 ±10°C 90 seconds
		Soldering: 255 ±5°C for 3 ±1 sec
Shock	Inductance change within ± 5% Without mechanical damage	Drop down with 981m/s ² (100G) shock
		Attitude upon a rubber block method shock testing machinem, 3 tests.
Vibration	Inductance change within ± 5% Without mechanical damage	Vibration frequency: 10Hz to 55Hz to 10Hz, 60 seconds cycle.
		Vibration time: 2 hours

ENDURANCE RELIABILITY

TEST	Specification & Requirement	Method Used
Thermal Shock	Inductance change within ± 5% Without mechanical damage	-25°C ,(30 mins) -> room temp. (5 mins) ->125°C , (30 mins) -> room temp. (5 mins) 100 cycles
Heat Resistance	Inductance change within ± 5% Without mechanical damage	Apply IDC current @ 85°C ambient Duration: 1000 hrs
Humidity Resistance	Inductance change within ± 5% Without mechanical damage	Apply IDC current @ 60°C ambient Humidity: 90~95% Duration: 1000 hrs
Low Temp. Storing	Inductance change within ± 5% Without mechanical damage	Storing Temp -25 ±2 °C for total 1,000 +4/-0 hours
High Temp. Storing	Inductance change within ± 5% Without mechanical damage	Storing Temp 125±2 °C for total 1,000 +4/-0 hours

Version:1.0	CUSTOMER P/N		PRODUCT	SMD Inductor
	ITEM P/N	SICM0510-2R2M	DATE	2022-Sep-06



深圳市磁立方科技有限公司
ShenZhen Magnetic Cube Technology Co., LTD.

TEL:0755-23018051 E-FAX:0755-22140304 E-MAIL:Sales@mct8.com HTTP:www.mct8.com
ADD:F2, Building C, Furong Road No.8 , Tantou, Songgang, Baoan District, Shenzhen



PACKING INFORMATION

Packing Information:(unit: mm)

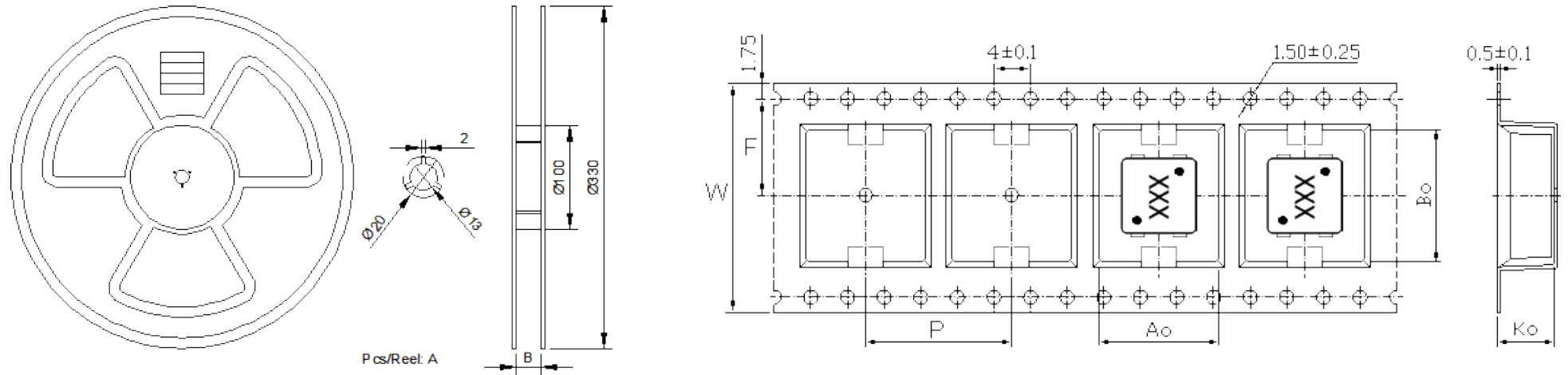

Series	A(Pcs/Reel)	B	W	P	Ao	Bo	Ko
SICM0510-2R2M	300	32.5±0.5	32	20	13.8±0.15	15.8±0.15	10.9±0.1

Typical Pulling Force: 20~130grams

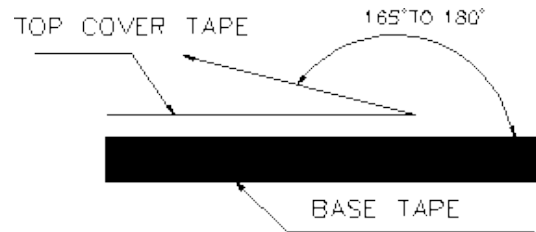

Version:1.0	CUSTOMER P/N		PRODUCT	SMD Inductor
	ITEM P/N	SICM0510-2R2M	DATE	2022-Sep-06



深圳市磁立方科技有限公司
ShenZhen Magnetic Cube Technology Co., LTD.

TEL:0755-23018051 E-FAX:0755-22140304 E-MAIL:Sales@mct8.com HTTP:www.mct8.com
ADD:F2, Building C, Furong Road No.8 , Tantou, Songgang, Baoan District, Shenzhen

