



磁立方

SPECIFICATION FOR APPROVAL

CUSTOMER : _____

CUSTOMER P/N : _____

DESCRIPTION : SMD Inductor

Supplier P/N : ACLS0807MN-R30M

REVISION NO. : V1.0

DATE : 2021-Jan-14

NOTES : STANDARD

Supplier DOCUMENTED	
APPROVED	David
CHECKED	Zhao yun
PREPARED	You yuan

CUSTOMER APPROVAL	

© Company seals

Version:1.0	CUSTOMER P/N		PRODUCT	SMD Inductor
	ITEM P/N	ACLS0807MN-R30M	DATE	2021-Jan-14



深圳市磁立方科技有限公司
ShenZhen Magnetic Cube Technology Co., LTD.

TEL:0755-23018051 E-FAX:0755-22140304 E-MAIL:Sales@mct8.com HTTP:www.mct8.com
ADD:F2, Building C, Furong Road No.8 , Tantou, Songgang, Baoan District, Shenzhen



MAIN SPECIFICATION

EXPLANATION OF PART NUMBERS

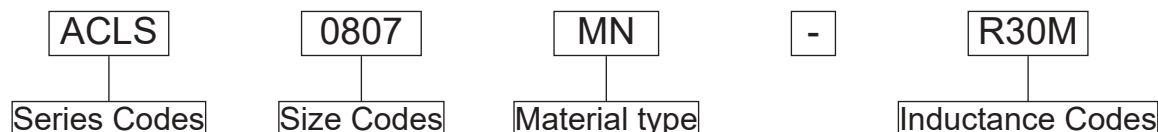

PRODUCT DIMENSIONS (mm)

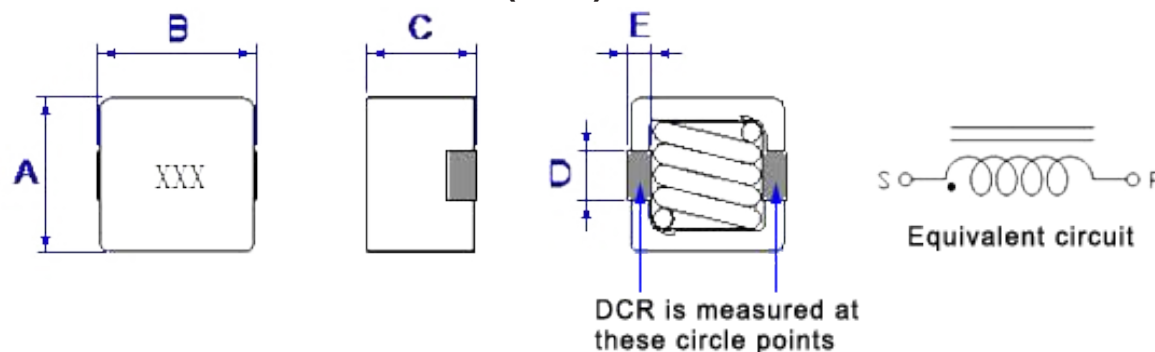

	Dimensions
A	7.9±0.4
B	8.4±0.4
C	7.2±0.4
D	2.3±0.2
E	1.5±0.2

ELECTRICAL CHARACTERISTICS

ITEM P/N	@ 25 ± 5°C Ambient Temperature			DCR mΩ @ 25°C Typica	DCR mΩ @ 25°C Max
	INDUCTANCE 100KHz, 0.1V	Typical Heat Rating DC Current (A) (I _{dc})	Typical Saturation DC Current (A) (I _{sat})		
	Lo (μH)				
ACLS0807MN-R30M	0.3±20%	20.5	36.0	2.3	2.7

- ⊙ All test Data is referenced to 25°C ambient.
- ⊙ Typical Heat Rating DC Current would cause an approximately Δ T of 50°C .
- ⊙ Typical Saturation DC Current would cause Lo to drop approximately 30%.
- ⊙ The Part temperature (ambient + Δ T) should not exceed 125°C under worst case operating conditions.
- ⊙ Circuit design, component placement, PWB trace size and thickness, airflow and other cooling provisions all effect the part temperature. Part temperature should be verified in the end application.

Version:1.0	CUSTOMER P/N	PRODUCT	SMD Inductor
	ITEM P/N	ACLS0807MN-R30M	DATE



深圳市磁立方科技有限公司
 ShenZhen Magnetic Cube Technology Co., LTD.

TEL:0755-23018051 E-FAX:0755-22140304 E-MAIL:Sales@mct8.com HTTP:www.mct8.com
 ADD:F2, Building C, Furong Road No.8 , Tantou, Songgang, Baoan District, Shenzhen



CHARACTERISTICS

Typical Inductance vs. Current Characteristics:

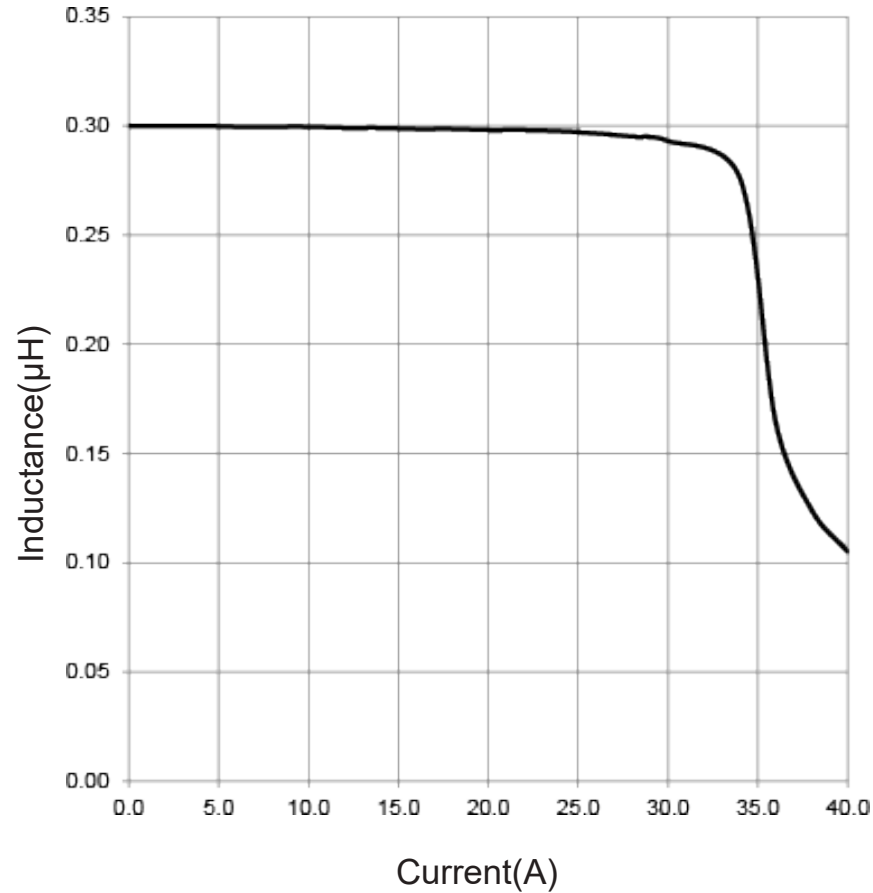

Typical Temperature Rise vs. Current Characteristics:

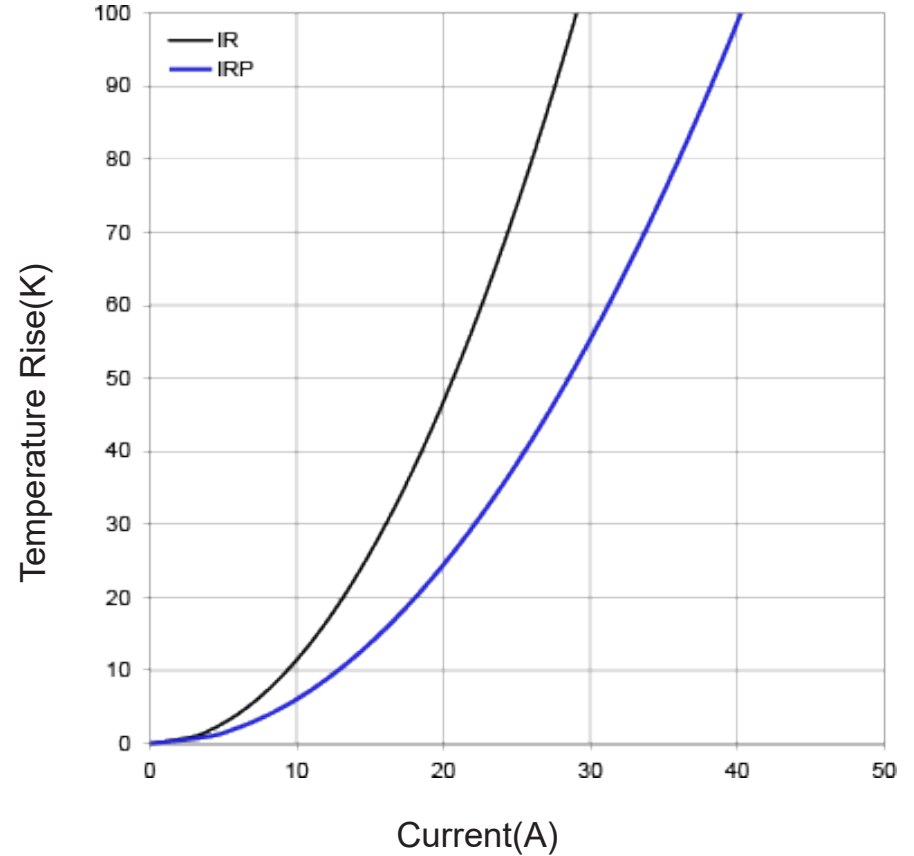

Version:1.0	CUSTOMER P/N		PRODUCT	SMD Inductor
	ITEM P/N	ACLS0807MN-R30M	DATE	2021-Jan-14



深圳市磁立方科技有限公司
ShenZhen Magnetic Cube Technology Co., LTD.

TEL:0755-23018051 E-FAX:0755-22140304 E-MAIL:Sales@mct8.com HTTP:www.mct8.com
ADD:F2, Building C, Furong Road No.8, Tantou, Songgang, Baoan District, Shenzhen



CHARACTERISTICS

RECOMMENDED SOLDERING TEMP. GRAPH

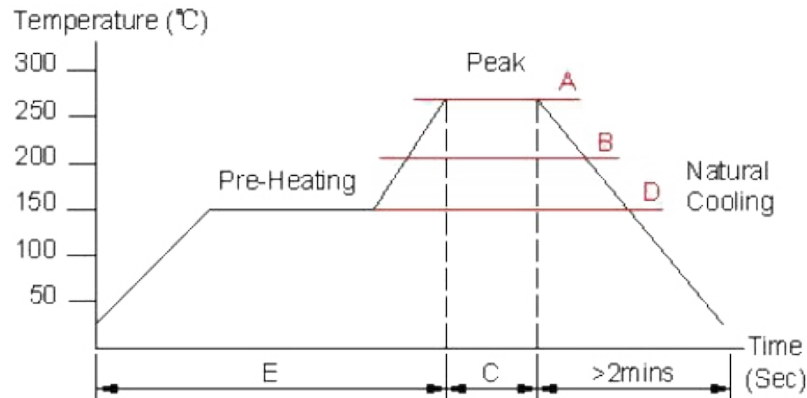

A	B	C	D	E
260°C	230°C	10Sec	150°C	60~240Sec

MECHANICAL RELIABILITY

TEST	Specification & Requirement	Method Used
Solderability	The surface of terminal/pin tested shall be covered with new solder by 95%	Solder heat proof.
		Preheating:180 ±10°C 90 seconds
		Soldering:255 ±5°C for 3 ±1 sec
Shock	Inductance change within ± 5% Without mechanical damage	Drop down with 981m/s2 (100G) shock
		Attitude upon a rubber block method shock testing machinem, 3 tests.
Vibration	Inductance change within ± 5% Without mechanical damage	Vibration frequency:10Hz to 55Hz to 10Hz, 60 seconds cycle.
		Vibration time: 2 hours

ENDURANCE RELIABILITY

TEST	Specification & Requirement	Method Used
Thermal Shock	Inductance change within ± 5% Without mechanical damage	-25°C ,(30 mins) -> room temp. (5 mins) ->125°C , (30 mins) -> room temp. (5 mins)100 cycles
Heat Resistance	Inductance change within ± 5% Without mechanical damage	Apply IDC current @ 85°C ambient Duration: 1000 hrs
Humidity Resistance	Inductance change within ± 5% Without mechanical damage	Apply IDC current @ 60°C ambient Humidity: 90~95% Duration: 1000 hrs
Low Temp. Storing	Inductance change within ± 5% Without mechanical damage	Storing Temp -25 ±2 °C for total 1,000 +4/-0 hours
High Temp. Storing	Inductance change within ± 5% Without mechanical damage	Storing Temp 125±2 °C for total 1,000 +4/-0 hours

Version:1.0	CUSTOMER P/N		PRODUCT	SMD Inductor
	ITEM P/N	ACLS0807MN-R30M	DATE	2021-Jan-14



深圳市磁立方科技有限公司
ShenZhen Magnetic Cube Technology Co., LTD.

TEL:0755-23018051 E-FAX:0755-22140304 E-MAIL:Sales@mct8.com HTTP:www.mct8.com
ADD:F2, Building C, Furong Road No.8 , Tantou, Songgang, Baoan District, Shenzhen



PACKING INFORMATION

CARRIER TAPEING REEL & CARRIER MATERIALS (PAPER PLASTICS) UNIT: (mm)

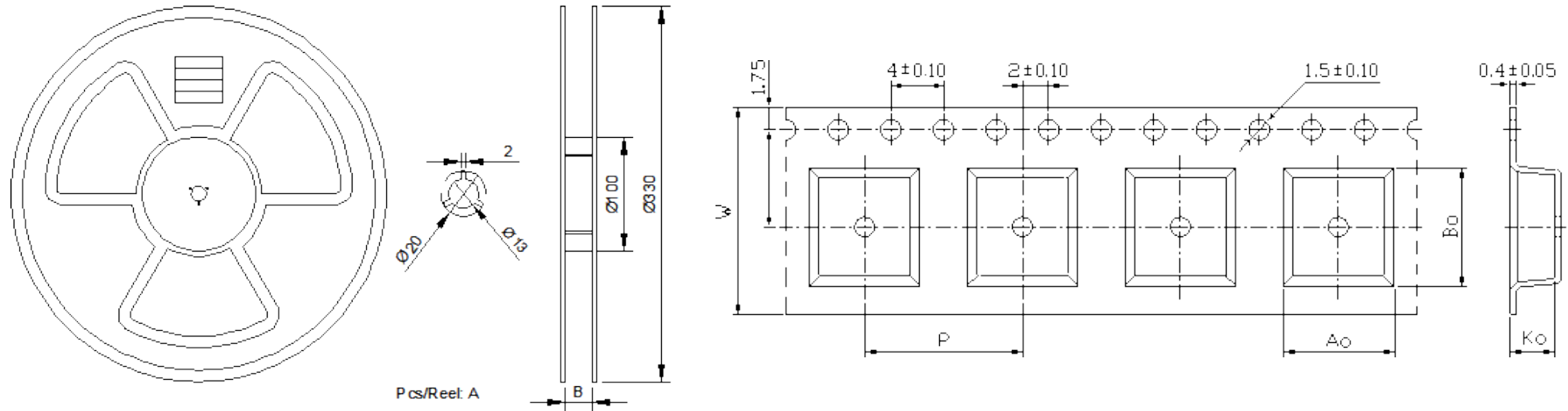

A(Pcs/Reel)	B
500	24.5±0.5

W	P	Ao	Bo	Ko
24	16	8.0±0.1	9.0±0.1	7.0±0.15

Typical Pulling Force: 20 ~ 130 grams:

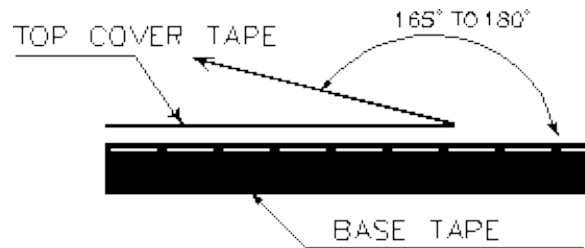

Version:1.0	CUSTOMER P/N	PRODUCT	SMD Inductor
	ITEM P/N	ACLS0807MN-R30M	DATE



深圳市磁立方科技有限公司
ShenZhen Magnetic Cube Technology Co., LTD.

TEL:0755-23018051 E-FAX:0755-22140304 E-MAIL:Sales@mct8.com HTTP:www.mct8.com
ADD:F2, Building C, Furong Road No.8, Tantou, Songgang, Baoan District, Shenzhen

