



磁立方

# SPECIFICATION FOR APPROVAL

**CUSTOMER** : \_\_\_\_\_

**CUSTOMER P/N** : \_\_\_\_\_

**DESCRIPTION** : SMD Inductor

**Supplier P/N** : SER2918H-100M

**REVISION NO.** : V1.0

**DATE** : 2022-Sep-06

**NOTES** : STANDARD

| Supplier DOCUMENTED |          |
|---------------------|----------|
| APPROVED            | David    |
| CHECKED             | Zhao yun |
| PREPARED            | You yuan |

| CUSTOMER APPROVAL |  |
|-------------------|--|
|                   |  |

© Company seals

|             |              |               |         |              |
|-------------|--------------|---------------|---------|--------------|
| Version:1.0 | CUSTOMER P/N |               | PRODUCT | SMD Inductor |
|             | ITEM P/N     | SER2918H-100M | DATE    | 2022-Sep-06  |



深圳市磁立方科技有限公司  
ShenZhen Magnetic Cube Technology Co., LTD.

TEL:0755-23018051 E-FAX:0755-22140304 E-MAIL:Sales@mct8.com HTTP:www.mct8.com  
ADD:F2, Building C, Furong Road No.8 , Tantou, Songgang, Baoan District, Shenzhen



# MAIN SPECIFICATION

## EXPLANATION OF PART NUMBERS

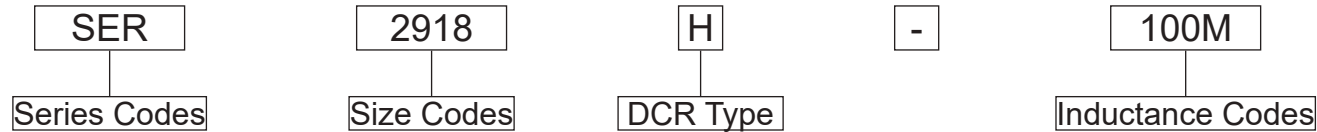

## PRODUCT DIMENSIONS (mm)

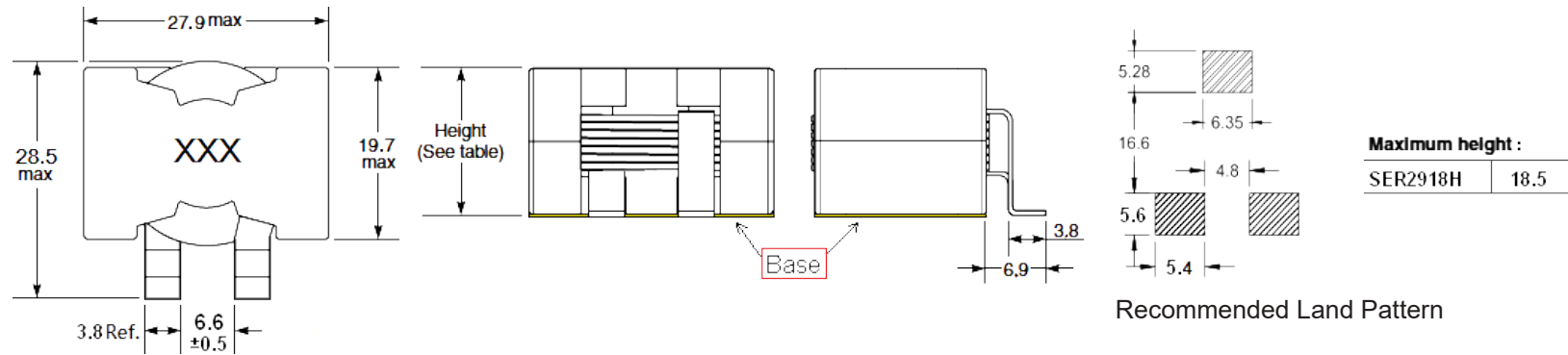

## ELECTRICAL CHARACTERISTICS

| ITEM P/N      | @ 25 ± 5°C Ambient Temperature |                                |                                 | DCR<br>mΩ @ 25°C<br>Typica | DCR<br>mΩ @ 25°C<br>Max |
|---------------|--------------------------------|--------------------------------|---------------------------------|----------------------------|-------------------------|
|               | INDUCTANCE<br>100KHz, 0.1V     | Typical Heat<br>Rating DC      | Typical<br>Saturation DC        |                            |                         |
|               | Lo (μH)                        | Current (A) (I <sub>dc</sub> ) | Current (A) (I <sub>sat</sub> ) |                            |                         |
| SER2918H-100M | 10±20%                         | 28.0                           | 32.1                            | 2.45                       | 2.8                     |

- ⊙ All test Data is referenced to 25°C ambient.
- ⊙ I<sub>rms</sub>: DC current(A) that will cause an approximate Δ T of 40°C .
- ⊙ I<sub>sat</sub>: DC current(A) that will cause Lo to drop approximate 30%.
- ⊙ Operating temperature range is -25°C to 125°C .
- ⊙ The part temperature(ambient and temp rise) should not exceed 125°C under worse case operating conditions. Circuit design, component placement, PWB trace size and thickness, airflow and other cooling provision all affect the part temperature. Part temperature should be verified in the end application.
- ⊙ Rights of changing product's design and specification are reserved, without prior notice.

|             |              |               |         |              |
|-------------|--------------|---------------|---------|--------------|
| Version:1.0 | CUSTOMER P/N |               | PRODUCT | SMD Inductor |
|             | ITEM P/N     | SER2918H-100M | DATE    | 2022-Sep-06  |

**深圳市磁立方科技有限公司** TEL:0755-23018051 E-FAX:0755-22140304 E-MAIL:Sales@mct8.com HTTP:www.mct8.com  
 ShenZhen Magnetic Cube Technology Co., LTD. ADD:F2, Building C, Furong Road No.8 , Tantou, Songgang, Baoan District, Shenzhen



# CHARACTERISTICS

Temperature Rise vs. Current:

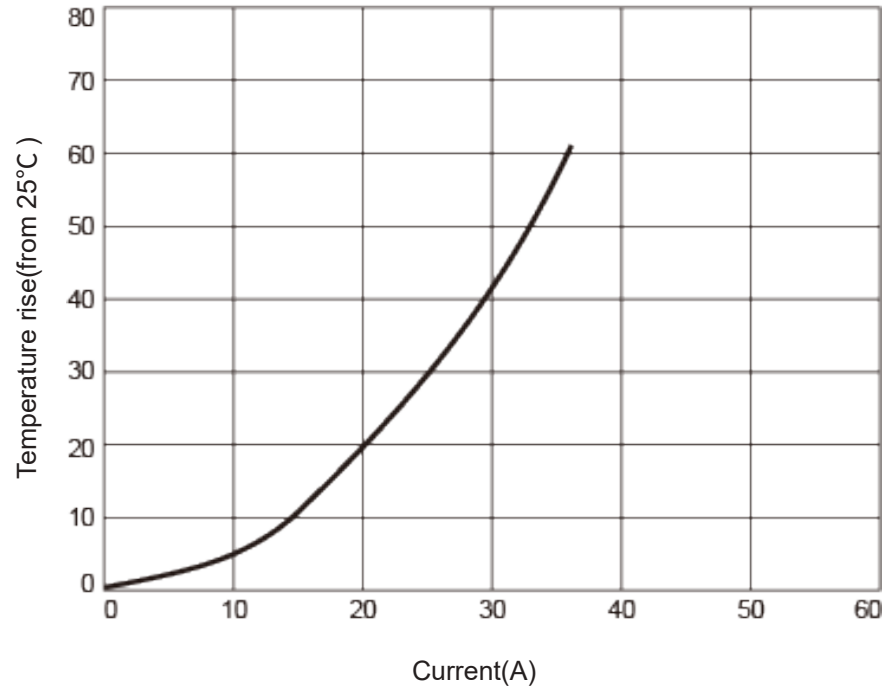

L vs Current:

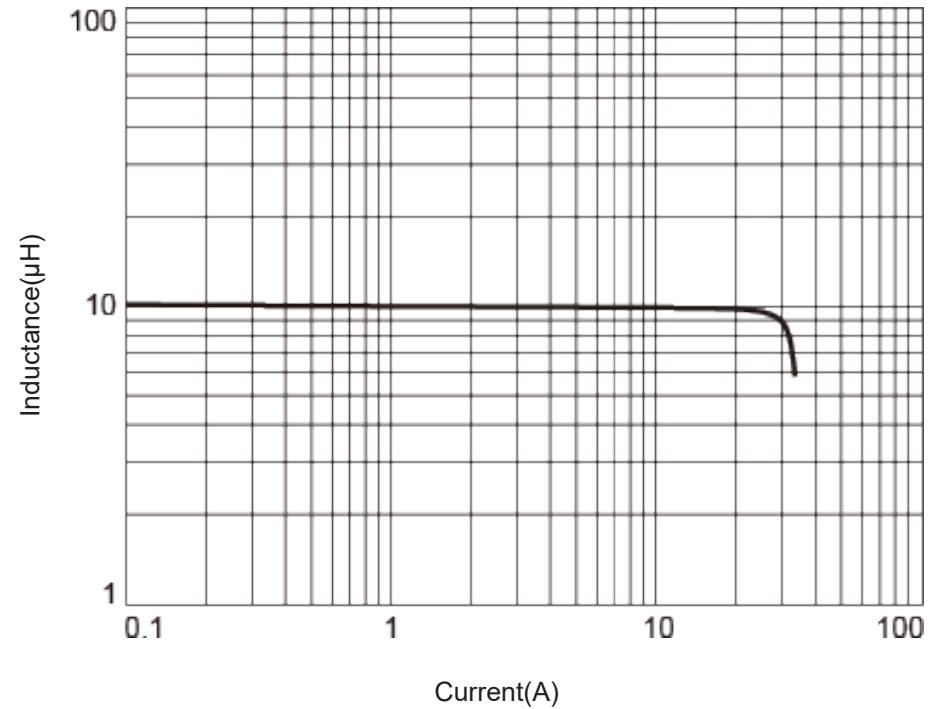

|             |              |               |         |              |
|-------------|--------------|---------------|---------|--------------|
| Version:1.0 | CUSTOMER P/N |               | PRODUCT | SMD Inductor |
|             | ITEM P/N     | SER2918H-100M | DATE    | 2022-Sep-06  |



深圳市磁立方科技有限公司  
ShenZhen Magnetic Cube Technology Co., LTD.

TEL:0755-23018051 E-FAX:0755-22140304 E-MAIL:Sales@mct8.com HTTP:www.mct8.com  
ADD:F2, Building C, Furong Road No.8 , Tantou, Songgang, Baoan District, Shenzhen



# CHARACTERISTICS

## RECOMMENDED SOLDERING TEMP. GRAPH



| A     | B     | C       | D     | E         |
|-------|-------|---------|-------|-----------|
| 260°C | 230°C | 8-10Sec | 150°C | 60~240Sec |

## MECHANICAL RELIABILITY

| TEST          | Specification & Requirement  | Method Used  |
|---------------|--|--|
| Solderability | The surface of terminal/pin tested shall be covered with new solder by 95% | Solder heat proof.   |
|               |  | Preheating: 180 ±10°C 90 seconds                                     |
|               |  | Soldering: 255 ±5°C for 3 ±1 sec                                     |
| Shock         | Inductance change within ± 5% Without mechanical damage                    | Drop down with 981m/s <sup>2</sup> (100G) shock                      |
|               |  | Attitude upon a rubber block method shock testing machinem, 3 tests. |
| Vibration     | Inductance change within ± 5% Without mechanical damage                    | Vibration frequency: 10Hz to 55Hz to 10Hz, 60 seconds cycle.         |
|               |  | Vibration time: 2 hours  |

## ENDURANCE RELIABILITY

| TEST                | Specification & Requirement                             | Method Used  |
|---------------------|---|--|
| Thermal Shock       | Inductance change within ± 5% Without mechanical damage | -25°C ,(30 mins) -> room temp. (5 mins) ->125°C , (30 mins) -> room temp. (5 mins)100 cycles |
| Heat Resistance     | Inductance change within ± 5% Without mechanical damage | Apply IDC current @ 85°C ambient Duration: 1000 hrs  |
| Humidity Resistance | Inductance change within ± 5% Without mechanical damage | Apply IDC current @ 60°C ambient Humidity: 90~95% Duration: 1000 hrs                         |
| Low Temp. Storing   | Inductance change within ± 5% Without mechanical damage | Storing Temp -25 ±2 °C for total 1,000 +4/-0 hours   |
| High Temp. Storing  | Inductance change within ± 5% Without mechanical damage | Storing Temp 125±2 °C for total 1,000 +4/-0 hours  |

|             |              |               |         |              |
|-------------|--------------|---------------|---------|--------------|
| Version:1.0 | CUSTOMER P/N |               | PRODUCT | SMD Inductor |
|             | ITEM P/N     | SER2918H-100M | DATE    | 2022-Sep-06  |



深圳市磁立方科技有限公司  
ShenZhen Magnetic Cube Technology Co., LTD.

TEL:0755-23018051 E-FAX:0755-22140304 E-MAIL:Sales@mct8.com HTTP:www.mct8.com  
ADD:F2, Building C, Furong Road No.8 , Tantou, Songgang, Baoan District, Shenzhen



# PACKING INFORMATION

**Packing Information:(unit: mm)**

1.PET plate specification: 322\*202\*24mm,35pcs/PET Box

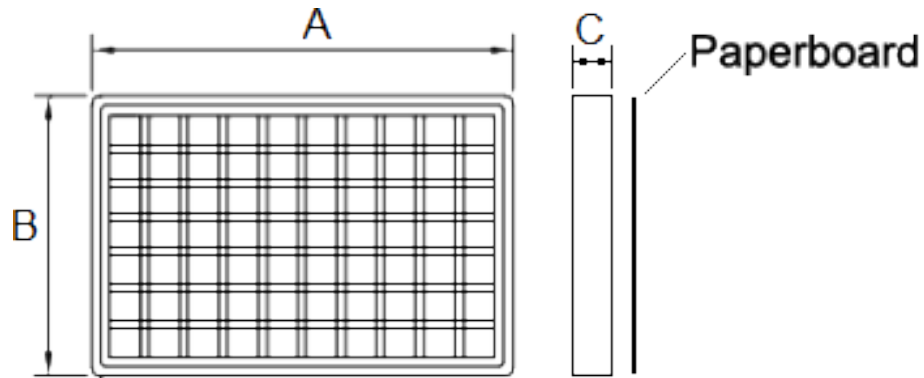

2.Outer box specification: 340\*215\*220mm,  
8 PET plate in one box

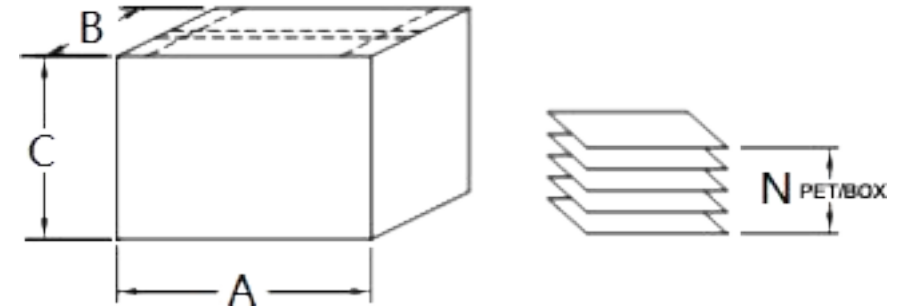

| Series Name and Note | Plastic Plate(mm) | Outer Box(mm) |
|----------------------|-------------------|---------------|
| SER2918H(带底板)        | 35pcs/PET Box     | 280pcs/Box    |

|             |              |               |         |              |
|-------------|--------------|---------------|---------|--------------|
| Version:1.0 | CUSTOMER P/N |               | PRODUCT | SMD Inductor |
|             | ITEM P/N     | SER2918H-100M | DATE    | 2022-Sep-06  |



**深圳市磁立方科技有限公司**  
ShenZhen Magnetic Cube Technology Co., LTD.

TEL:0755-23018051 E-FAX:0755-22140304 E-MAIL:Sales@mct8.com HTTP:www.mct8.com  
ADD:F2, Building C, Furong Road No.8 , Tantou, Songgang, Baoan District, Shenzhen

