



磁立方

# SPECIFICATION FOR APPROVAL

**CUSTOMER** : \_\_\_\_\_

**CUSTOMER P/N** : \_\_\_\_\_

**DESCRIPTION** : SMD Inductor

**Supplier P/N** : SER2918H-150M

**REVISION NO.** : V1.0

**DATE** : 2022-Sep-06

**NOTES** : STANDARD

Supplier DOCUMENTED	
APPROVED	David
CHECKED	Zhao yun
PREPARED	You yuan

CUSTOMER APPROVAL	

© Company seals

Version:1.0	CUSTOMER P/N		PRODUCT	SMD Inductor
	ITEM P/N	SER2918H-150M	DATE	2022-Sep-06



深圳市磁立方科技有限公司  
ShenZhen Magnetic Cube Technology Co., LTD.

TEL:0755-23018051 E-FAX:0755-22140304 E-MAIL:Sales@mct8.com HTTP:www.mct8.com  
ADD:F2, Building C, Furong Road No.8 , Tantou, Songgang, Baoan District, Shenzhen



# MAIN SPECIFICATION

## EXPLANATION OF PART NUMBERS

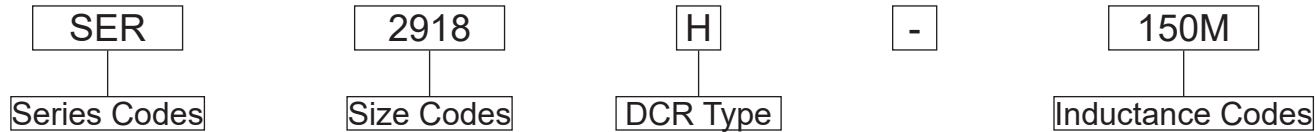

## PRODUCT DIMENSIONS (mm)

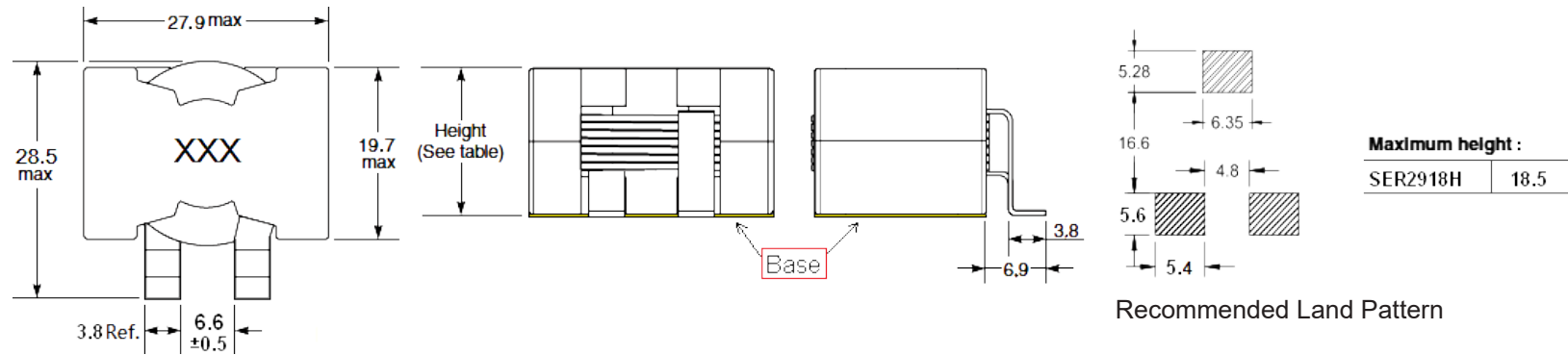

## ELECTRICAL CHARACTERISTICS

ITEM P/N	@ 25 ± 5°C Ambient Temperature			DCR mΩ @ 25°C Typica	DCR mΩ @ 25°C Max
	INDUCTANCE 100KHz, 0.1V	Typical Heat Rating DC	Typical Saturation DC		
	Lo (μH)	Current (A) (I <sub>dc</sub> )	Current (A) (I <sub>sat</sub> )		
SER2918H-150M	15±20%	28.0	21.9	2.45	2.8

- ⊙ All test Data is referenced to 25°C ambient.
- ⊙ I<sub>rms</sub>: DC current(A) that will cause an approximate Δ T of 40°C .
- ⊙ I<sub>sat</sub>: DC current(A) that will cause Lo to drop approximate 30%.
- ⊙ Operating temperature range is -25°C to 125°C .
- ⊙ The part temperature(ambient and temp rise) should not exceed 125°C under worse case operating conditions. Circuit design, component placement, PWB trace size and thickness, airflow and other cooling provision all affect the part temperature. Part temperature should be verified in the end application.
- ⊙ Rights of changing product's design and specification are reserved, without prior notice.

Version:1.0	CUSTOMER P/N		PRODUCT	SMD Inductor
	ITEM P/N	SER2918H-150M	DATE	2022-Sep-06

**深圳市磁立方科技有限公司** TEL:0755-23018051 E-FAX:0755-22140304 E-MAIL:Sales@mct8.com HTTP:www.mct8.com  
 ShenZhen Magnetic Cube Technology Co., LTD. ADD:F2, Building C, Furong Road No.8 , Tantou, Songgang, Baoan District, Shenzhen



# CHARACTERISTICS

Temperature Rise vs. Current:

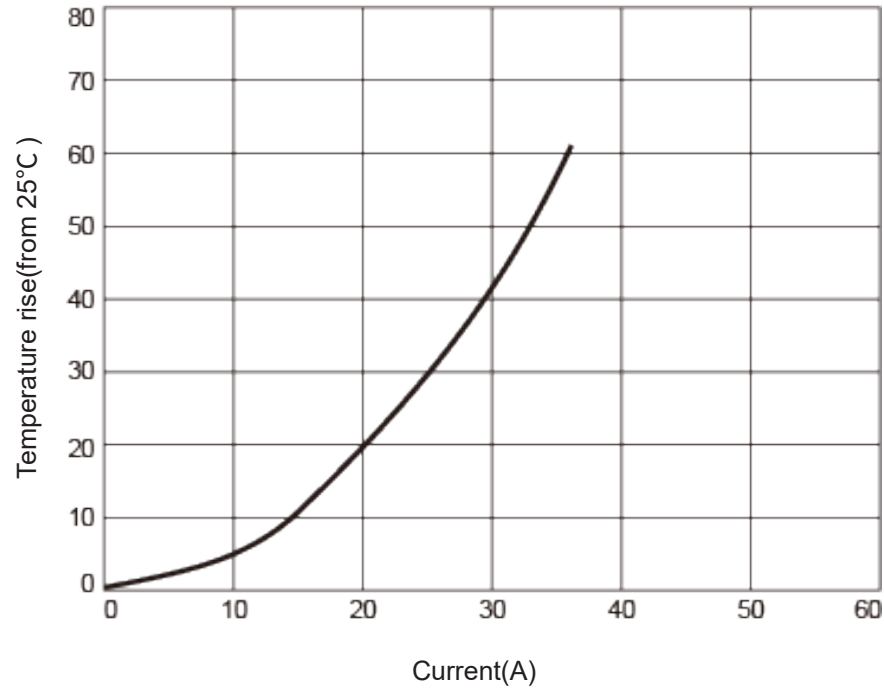

L vs Current:

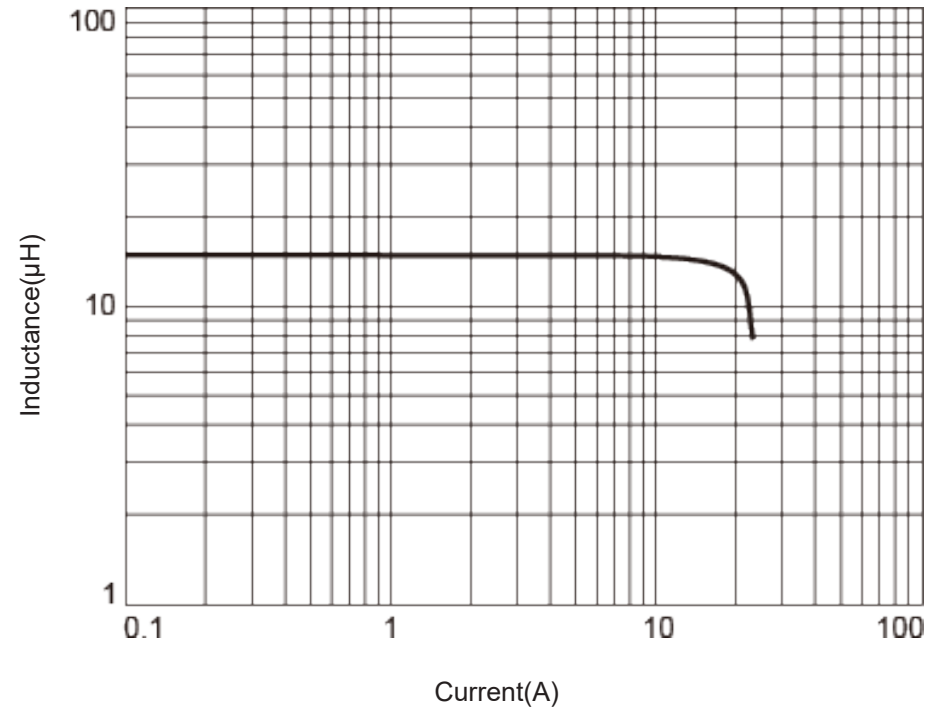

Version:1.0	CUSTOMER P/N		PRODUCT	SMD Inductor
	ITEM P/N	SER2918H-150M	DATE	2022-Sep-06



深圳市磁立方科技有限公司  
ShenZhen Magnetic Cube Technology Co., LTD.

TEL:0755-23018051 E-FAX:0755-22140304 E-MAIL:Sales@mct8.com HTTP:www.mct8.com  
ADD:F2, Building C, Furong Road No.8, Tantou, Songgang, Baoan District, Shenzhen



# CHARACTERISTICS

## RECOMMENDED SOLDERING TEMP. GRAPH



A	B	C	D	E
260°C	230°C	8-10Sec	150°C	60~240Sec

## MECHANICAL RELIABILITY

TEST	Specification & Requirement	Method Used
Solderability	The surface of terminal/pin tested shall be covered with new solder by 95%	Solder heat proof.
		Preheating: 180 ±10°C 90 seconds
		Soldering: 255 ±5°C for 3 ±1 sec
Shock	Inductance change within ± 5% Without mechanical damage	Drop down with 981m/s <sup>2</sup> (100G) shock
		Attitude upon a rubber block method shock testing machine, 3 tests.
Vibration	Inductance change within ± 5% Without mechanical damage	Vibration frequency: 10Hz to 55Hz to 10Hz, 60 seconds cycle.
		Vibration time: 2 hours

## ENDURANCE RELIABILITY

TEST	Specification & Requirement	Method Used
Thermal Shock	Inductance change within ± 5% Without mechanical damage	-25°C ,(30 mins) -> room temp. (5 mins) ->125°C , (30 mins) -> room temp. (5 mins) 100 cycles
Heat Resistance	Inductance change within ± 5% Without mechanical damage	Apply IDC current @ 85°C ambient Duration: 1000 hrs
Humidity Resistance	Inductance change within ± 5% Without mechanical damage	Apply IDC current @ 60°C ambient Humidity: 90~95% Duration: 1000 hrs
Low Temp. Storing	Inductance change within ± 5% Without mechanical damage	Storing Temp -25 ±2 °C for total 1,000 +4/-0 hours
High Temp. Storing	Inductance change within ± 5% Without mechanical damage	Storing Temp 125±2 °C for total 1,000 +4/-0 hours

Version:1.0	CUSTOMER P/N		PRODUCT	SMD Inductor
	ITEM P/N	SER2918H-150M	DATE	2022-Sep-06



深圳市磁立方科技有限公司  
ShenZhen Magnetic Cube Technology Co., LTD.

TEL:0755-23018051 E-FAX:0755-22140304 E-MAIL:Sales@mct8.com HTTP:www.mct8.com  
ADD:F2, Building C, Furong Road No.8 , Tantou, Songgang, Baoan District, Shenzhen



# PACKING INFORMATION

Packing Information:(unit: mm)

1.PET plate specification: 322\*202\*24mm,35pcs/PET Box

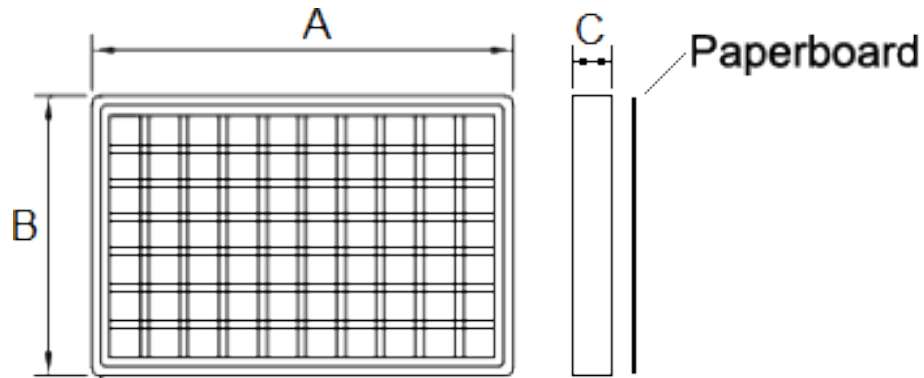

2.Outer box specification: 340\*215\*220mm,  
8 PET plate in one box

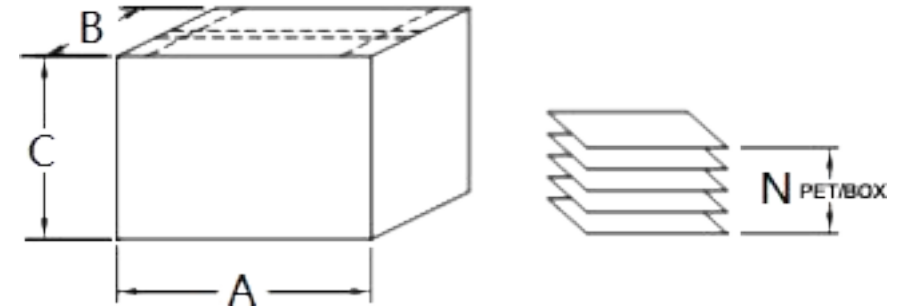

Series Name and Note	Plastic Plate(mm)	Outer Box(mm)
SER2918H(带底板)	35pcs/PET Box	280pcs/Box

Version:1.0	CUSTOMER P/N		PRODUCT	SMD Inductor
	ITEM P/N	SER2918H-150M	DATE	2022-Sep-06



深圳市磁立方科技有限公司  
ShenZhen Magnetic Cube Technology Co., LTD.

TEL:0755-23018051 E-FAX:0755-22140304 E-MAIL:Sales@mct8.com HTTP:www.mct8.com  
ADD:F2, Building C, Furong Road No.8 , Tantou, Songgang, Baoan District, Shenzhen

