



磁立方

SPECIFICATION FOR APPROVAL

CUSTOMER : _____

CUSTOMER P/N : _____

DESCRIPTION : SMD Inductor

Supplier P/N : TSB0660-4R7M

REVISION NO. : V1.0

DATE : 2021-Jan-14

NOTES : STANDARD

Supplier DOCUMENTED	
APPROVED	David
CHECKED	Zhao yun
PREPARED	You yuan

CUSTOMER APPROVAL	

© Company seals

Version:1.0	CUSTOMER P/N		PRODUCT	SMD Inductor
	ITEM P/N	TSB0660-4R7M	DATE	2021-Jan-14



深圳市磁立方科技有限公司
ShenZhen Magnetic Cube Technology Co., LTD.

TEL:0755-23018051 E-FAX:0755-22140304 E-MAIL:Sales@mct8.com HTTP:www.mct8.com
ADD:F2, Building C, Furong Road No.8 , Tantou, Songgang, Baoan District, Shenzhen



MAIN SPECIFICATION

EXPLANATION OF PART NUMBERS



PRODUCT DIMENSIONS (mm)



A	6.6±0.2
B	6.4±0.2
C	6.0Max
D	5.3Ref
E	1.4±0.3
F	2.6±0.3
G	2.5Ref
H	5.6Ref
L	5.6Ref

ELECTRICAL CHARACTERISTICS

ITEM P/N	@25 ± 5 °C Ambient Temperature			DCR mΩ @ 25°C Typica	DCR mΩ @ 25°C Max
	INDUCTANCE 100KHz, 0.1V	Typical Heat Rating DC Current (A) (I _{dc})	Typical Saturation DC Current (A) (I _{sat})		
	Lo (μH)				
TSB0660-4R7M	4.7±20%	11.0	10.5	12.52	14.4

- ⊙ All test Data is referenced to 25°C ambient.
- ⊙ I_{rms}: DC current(A) that will cause an approximate Δ T of 40°C .
- ⊙ I_{sat}: DC current(A) that will cause Lo to drop approximate 30%.
- ⊙ Operating temperature range is -25°C to 125°C .
- ⊙ The part temperature(ambient and temp rise) should not exceed 125°C under worse case operating conditions. Circuit design, component placement, PWB trace size and thickness, airflow and other cooling provision all affect the part temperature. Part temperature should be verified in the end application.

Version:1.0	CUSTOMER P/N		PRODUCT	SMD Inductor
	ITEM P/N	TSB0660-4R7M	DATE	2021-Jan-14

深圳市磁立方科技有限公司 TEL:0755-23018051 E-FAX:0755-22140304 E-MAIL:Sales@mct8.com HTTP:www.mct8.com
 ShenZhen Magnetic Cube Technology Co., LTD. ADD:F2, Building C, Furong Road No.8 , Tantou, Songgang, Baoan District, Shenzhen



CHARACTERISTICS

Typical L vs Current:

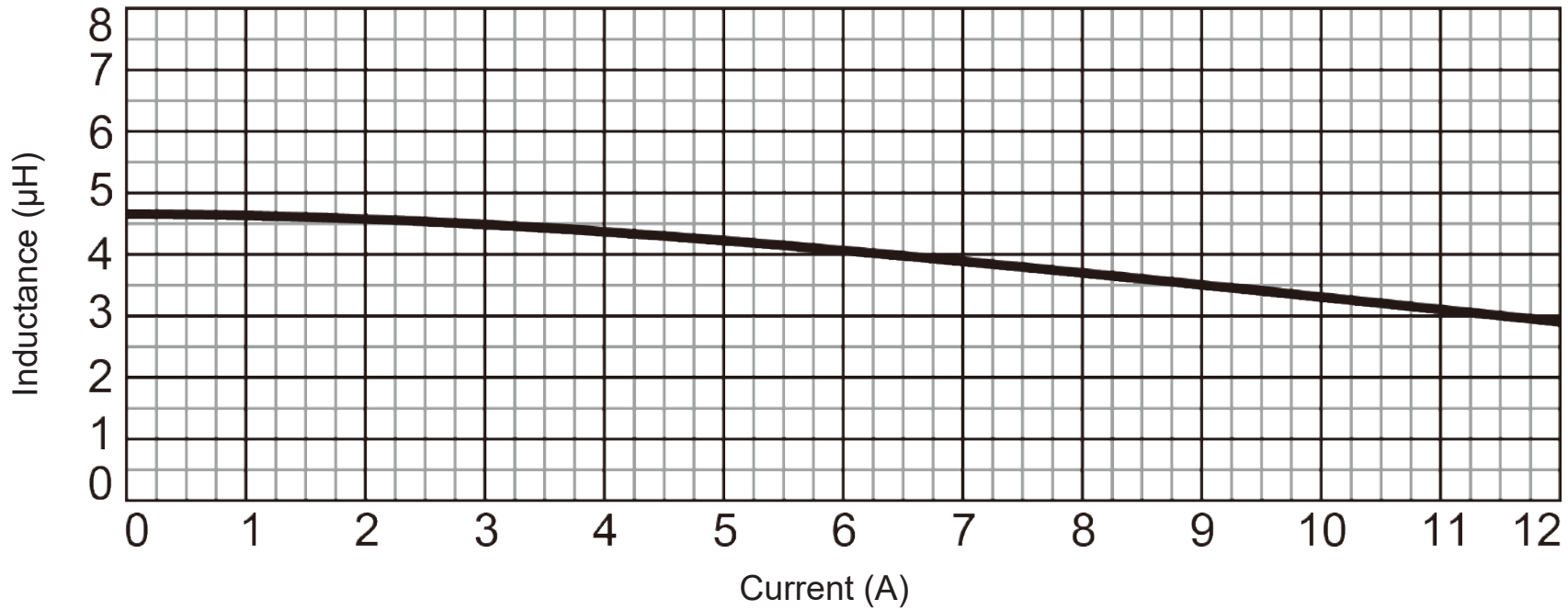

Version:1.0	CUSTOMER P/N		PRODUCT	SMD Inductor
	ITEM P/N	TSB0660-4R7M	DATE	2021-Jan-14



深圳市磁立方科技有限公司

ShenZhen Magnetic Cube Technology Co., LTD.

TEL:0755-23018051 E-FAX:0755-22140304 E-MAIL:Sales@mct8.com HTTP:www.mct8.com

ADD:F2, Building C, Furong Road No.8 , Tantou, Songgang, Baoan District, Shenzhen



CHARACTERISTICS

RECOMMENDED SOLDERING TEMP. GRAPH



A	B	C	D	E
260°C	230°C	8-10Sec	150°C	60~240Sec

MECHANICAL RELIABILITY

TEST	Specification & Requirement	Method Used
Solderability	The surface of terminal/pin tested shall be covered with new solder by 95%	Solder heat proof.
		Preheating: 180 ±10°C 90 seconds
		Soldering: 255 ±5°C for 3 ±1 sec
Shock	Inductance change within ± 5% Without mechanical damage	Drop down with 981m/s ² (100G) shock
		Attitude upon a rubber block method shock testing machine, 3 tests.
Vibration	Inductance change within ± 5% Without mechanical damage	Vibration frequency: 10Hz to 55Hz to 10Hz, 60 seconds cycle.
		Vibration time: 2 hours

ENDURANCE RELIABILITY

TEST	Specification & Requirement	Method Used
Thermal Shock	Inductance change within ± 5% Without mechanical damage	-25°C ,(30 mins) -> room temp. (5 mins) ->125°C , (30 mins) -> room temp. (5 mins) 100 cycles
Heat Resistance	Inductance change within ± 5% Without mechanical damage	Apply IDC current @ 85°C ambient Duration: 1000 hrs
Humidity Resistance	Inductance change within ± 5% Without mechanical damage	Apply IDC current @ 60°C ambient Humidity: 90~95% Duration: 1000 hrs
Low Temp. Storing	Inductance change within ± 5% Without mechanical damage	Storing Temp -25 ±2 °C for total 1,000 +4/-0 hours
High Temp. Storing	Inductance change within ± 5% Without mechanical damage	Storing Temp 125±2 °C for total 1,000 +4/-0 hours

Version:1.0	CUSTOMER P/N		PRODUCT	SMD Inductor
	ITEM P/N	TSB0660-4R7M	DATE	2021-Jan-14



深圳市磁立方科技有限公司
ShenZhen Magnetic Cube Technology Co., LTD.

TEL:0755-23018051 E-FAX:0755-22140304 E-MAIL:Sales@mct8.com HTTP:www.mct8.com
ADD:F2, Building C, Furong Road No.8 , Tantou, Songgang, Baoan District, Shenzhen



PACKING INFORMATION

CARRIER TAPEING REEL & CARRIER MATERIALS (PAPER PLASTICS) UNIT : (mm)

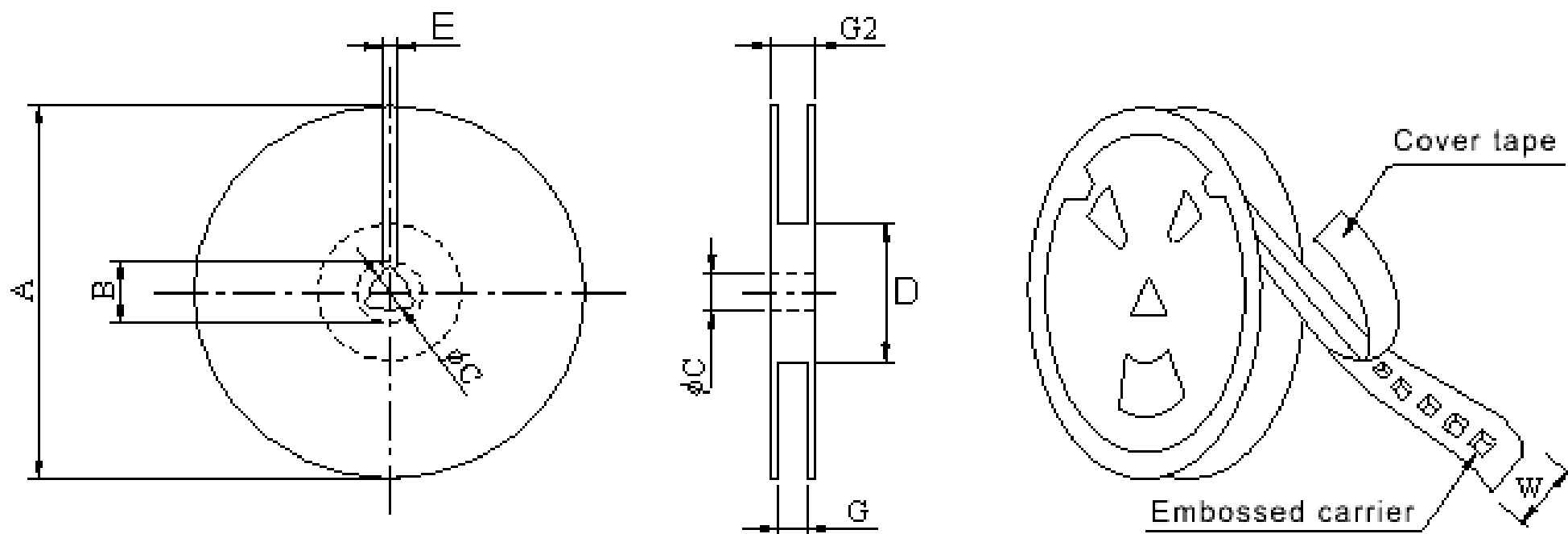

TYPE	A	B	C	D	E	G	G2
330*16mm	330±1	20±0.8	13±0.5	100±1	2.0±0.5	16.5±0.5	20.5±0.5

Version:1.0	CUSTOMER P/N		PRODUCT	SMD Inductor
	ITEM P/N	TSB0660-4R7M	DATE	2021-Jan-14



深圳市磁立方科技有限公司
ShenZhen Magnetic Cube Technology Co., LTD.

TEL:0755-23018051 E-FAX:0755-22140304 E-MAIL:Sales@mct8.com HTTP:www.mct8.com
ADD:F2, Building C, Furong Road No.8 , Tantou, Songgang, Baoan District, Shenzhen



PACKING INFORMATION

CARRIER TAPEING REEL & CARRIER MATERIALS (PAPER PLASTICS) UNIT : (mm)



QTY (Pcs/Reel)	Ao	Bo	Ko	W	P
750	7.0	6.8	6.3	16	12

Typical Pulling Force: 10~130grams:



Version:1.0	CUSTOMER P/N		PRODUCT	SMD Inductor
	ITEM P/N	TSB0660-4R7M		DATE



深圳市磁立方科技有限公司
ShenZhen Magnetic Cube Technology Co., LTD.

TEL:0755-23018051 E-FAX:0755-22140304 E-MAIL:Sales@mct8.com HTTP:www.mct8.com
ADD:F2, Building C, Furong Road No.8 , Tantou, Songgang, Baoan District, Shenzhen

